

# CONCRETE BLOCKS

## Technical Specification

Description	Length	Height	Thickness	Number in Bale	Approx Height KG	Approx Weight per bale
3" Soap	440	65	100	128	6	768
4" Soap	440	100	100	88	9	792
6" Soap	440	140	100	66	13	858
4" Standard	440	215	100	44	20	880
6" Block	440	215	140	32	27	864
12" Blocks	440	300	100	33	27	891
14" Block	340	215	100	44	13	572
L Blocks	440	215	100/155	16	23	368

## Block Dimensions

The following is a graphical representation of the various shapes and sizes of concrete block that we supply to the building industry.

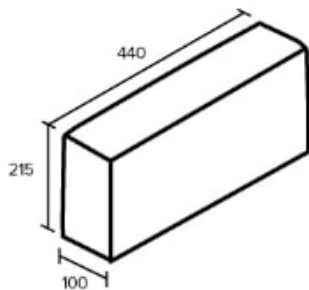

**4" Standards**

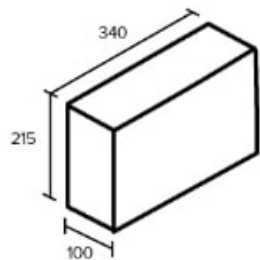

**14" Blocks**

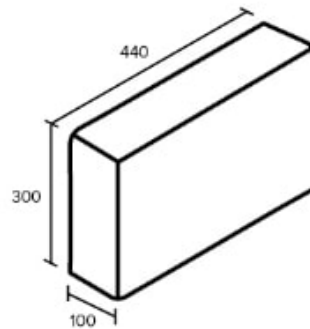

**12" Blocks**

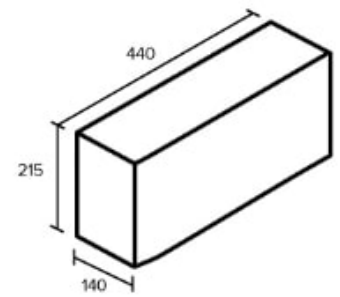

**6" Solid**

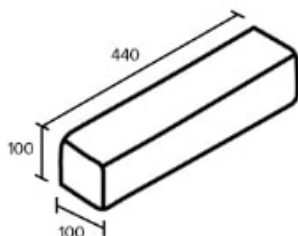

**4" Soap**

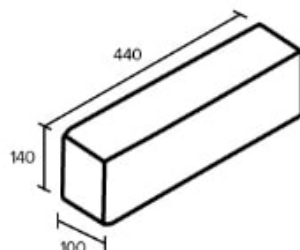

**6" Soap**

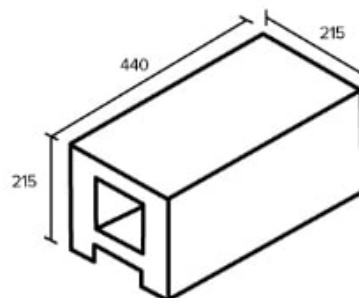

**Cavity Blocks**